

LONGITUD: 6,6 mts

**13149** PERFIL T DE 100x60x2mm

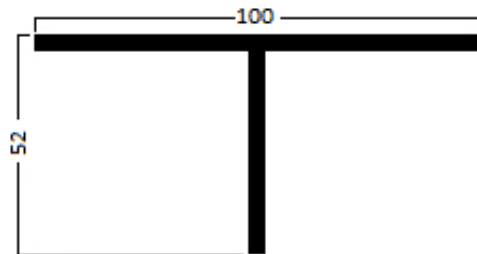

LONGITUD: 6,6 mts

**42024** PERFIL T DE 100x52x2mm

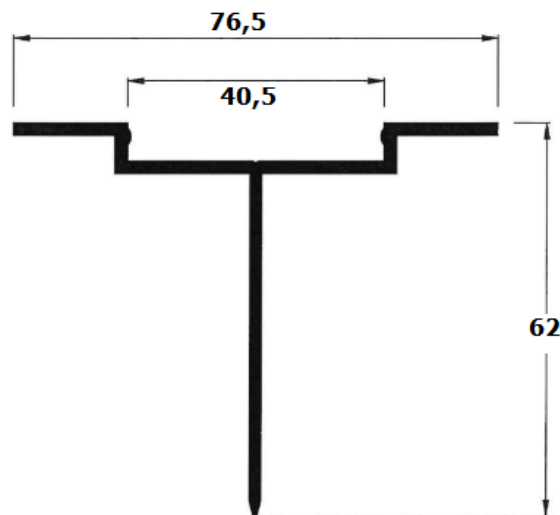

**NUEVO**

**6541** SIMPLE T CON HUELLA 76,5 x 62

# FACHADA VENTILADA

norperfil

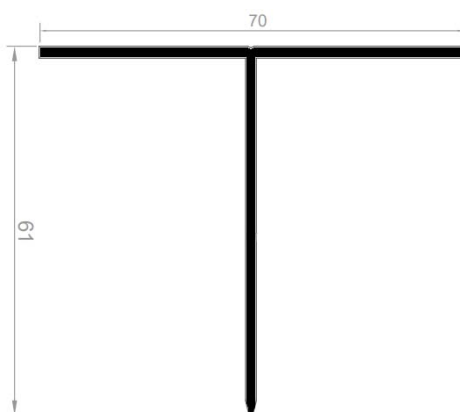

**10002** PERFIL T DE 70x61x2mm



**10003** PERFIL T DE 40x61x2mm

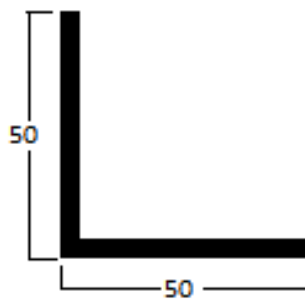

LONGITUD: 6,6 mts

**600867** ANGULAR 50x50x2mm

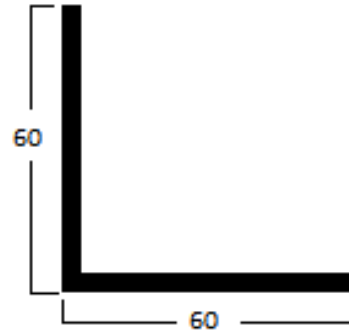

LONGITUD: 6,6 mts

**1102** ANGULAR 60x60x2mm

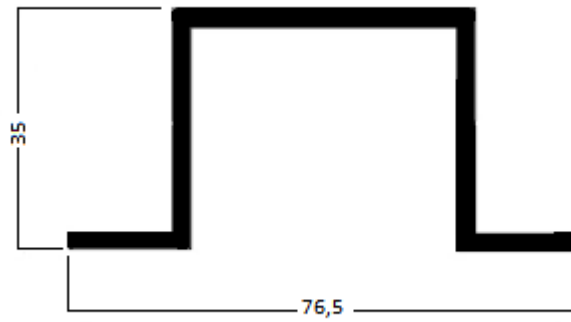

LONGITUD: 6,6 mts

**5674** OMEGA DE 45x76x2mm

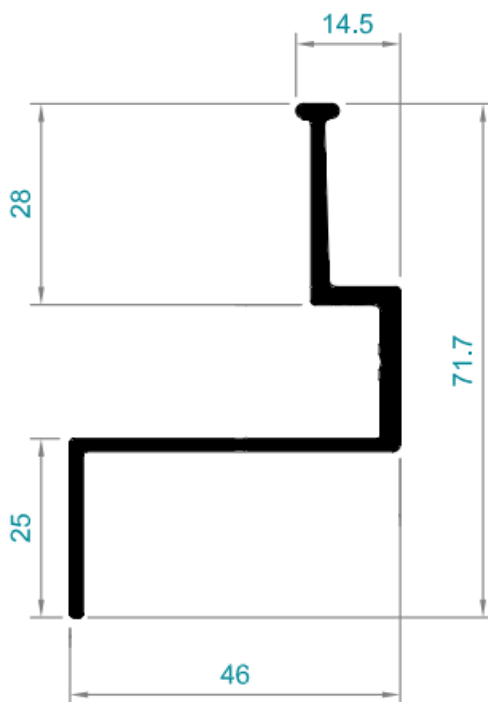

**E15453** FIJACION MACHO FACHADAS

**NUEVO**

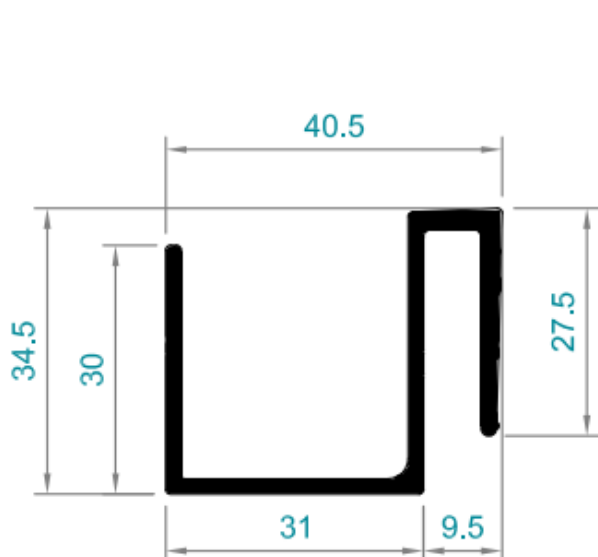

**E15454** "U" FACHADAS

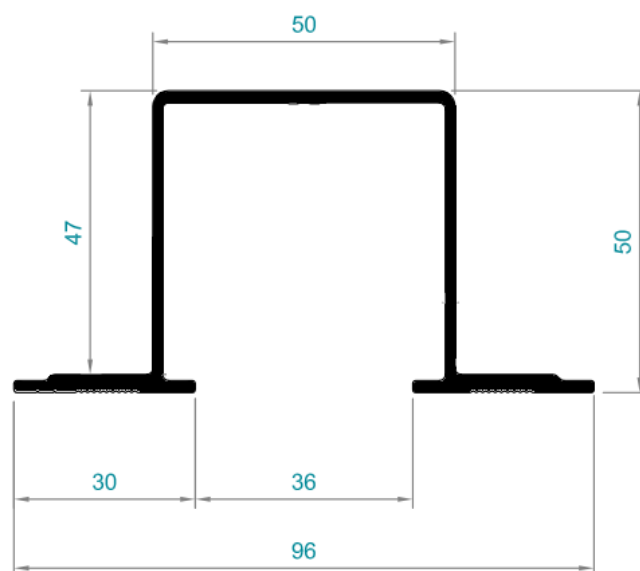

**E15452** OMEGA FACHADA 92mm

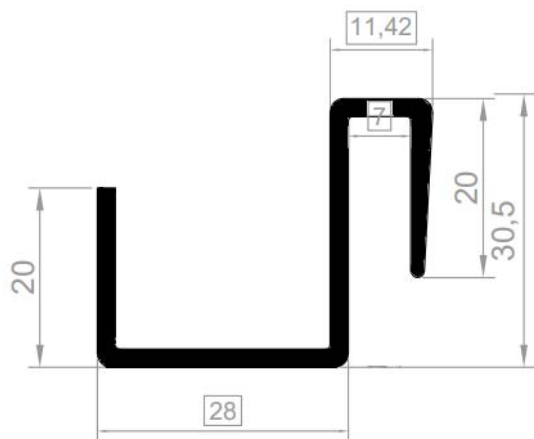

PERFIL HEMBRA FACHADAS

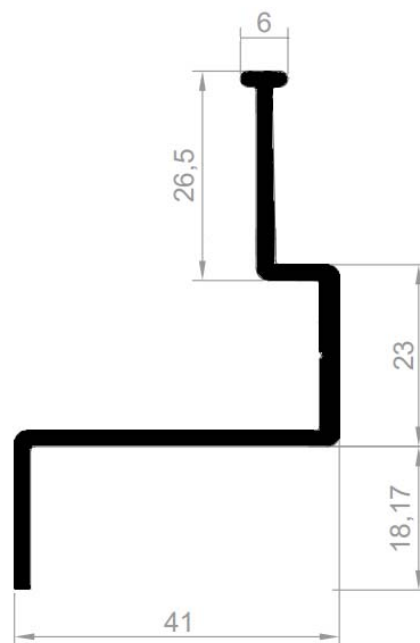

PERFIL FIJACION MACHO FACHADAS

**NUEVO**

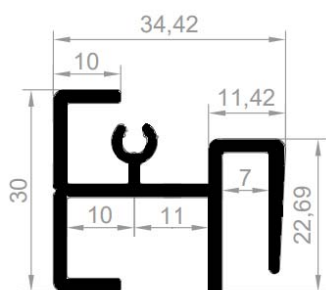

PERFIL RIGIDAZOR

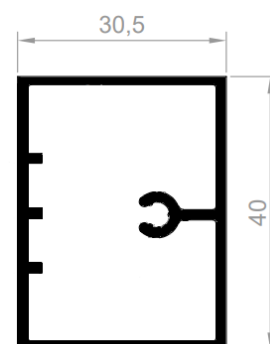

PERFIL REFUERZO HORIZONTAL

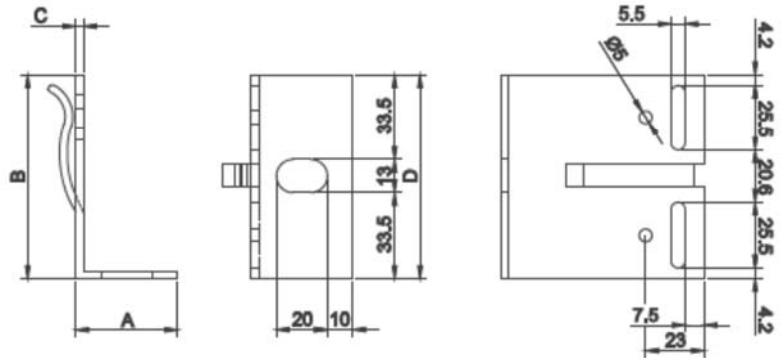
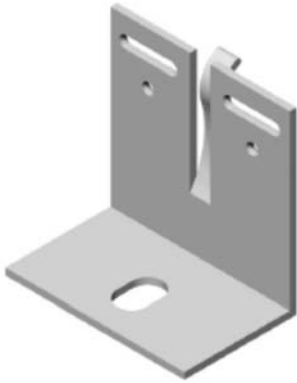

Escuadra de viento

DESCRIPCION	A	B	C	D	UNID/caja
MENSULA DE VIENTO CON PESTAÑA 40x40	40	40	3	80	150
MENSULA DE VIENTO CON PESTAÑA 40x60	40	60	3	80	150
MENSULA DE VIENTO CON PESTAÑA 40x80	40	80	3	80	150
MENSULA DE VIENTO CON PESTAÑA 40x100	40	100	3	80	150
MENSULA DE VIENTO CON PESTAÑA 40x120	40	120	3	80	150
MENSULA DE VIENTO CON PESTAÑA 40x140	40	140	3	80	150
MENSULA DE VIENTO CON PESTAÑA 40x160	40	160	3	80	120
MENSULA DE VIENTO CON PESTAÑA 50x180	50	180	4	80	100
MENSULA DE VIENTO CON PESTAÑA 60x200	60	200	4	80	100

# FACHADA VENTILADA

norperfil

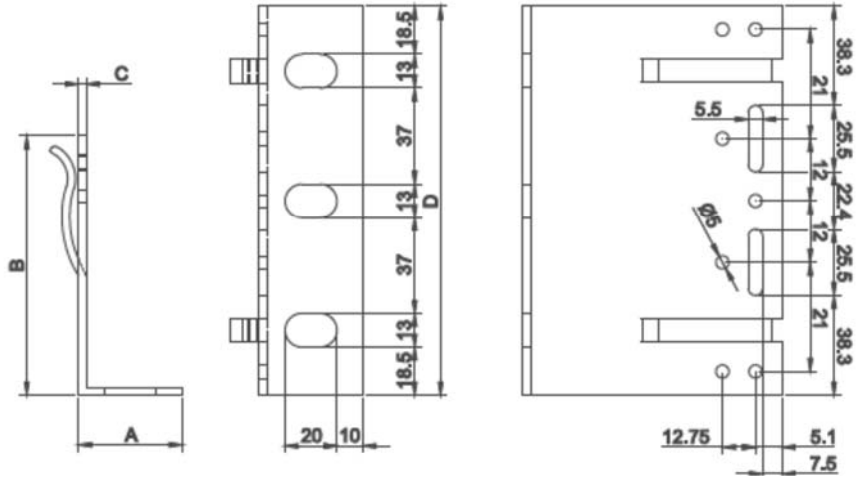
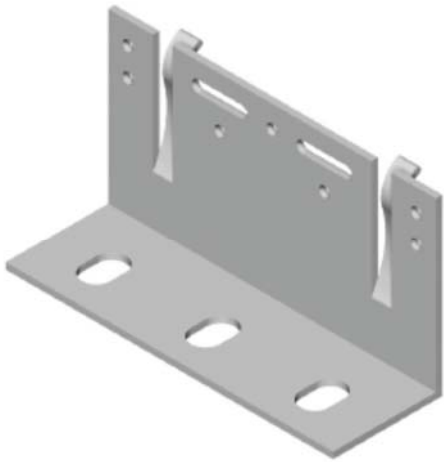

## Escuadra de carga

DESCRIPCION	A	B	C	D	UNID/caja
MENSULA DE CARGA CON PESTAÑA 40x40	40	40	3	150	150
MENSULA DE CARGA CON PESTAÑA 40x60	40	60	3	150	150
MENSULA DE CARGA CON PESTAÑA 40x80	40	80	3	150	150
MENSULA DE CARGA CON PESTAÑA 40x100	40	100	3	150	150
MENSULA DE CARAGA CON PESTAÑA 40x120	40	120	3	150	150
MENSULA DE CARGA CON PESTAÑA 40x140	40	140	3	150	150
MENSULA DE CARGA CON PESTAÑA 40x160	40	160	3	150	120
MENSULA DE CARGA CON PESTAÑA 50x180	50	180	4	150	100
MENSULA DE CARGA CON PESTAÑA 60x200	60	200	4	150	100

# FACHADA VENTILADA

norperfil

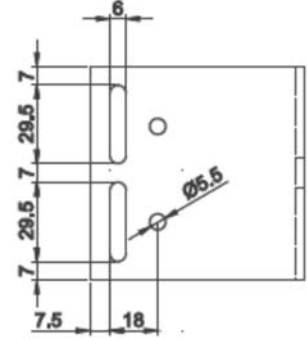
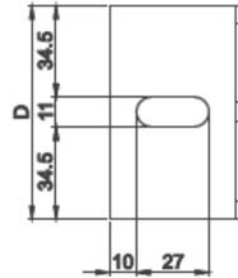
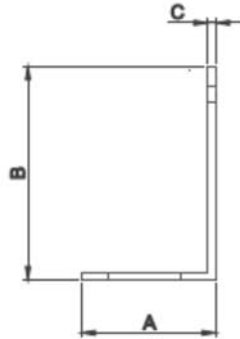

## Mensula de viento

DESCRIPCION	A	B	C	D	UNID/caja
MENSULA DE VIENTO SIN PESTAÑA 40x40	40	40	3	80	500
MENSULA DE VIENTO SIN PESTAÑA 40x60	40	60	3	80	450
MENSULA DE VIENTO SIN PESTAÑA 50x80	50	80	3	80	320
MENSULA DE VIENTO SIN PESTAÑA 50x100	50	100	3	80	280
MENSULA DE VIENTO SIN PESTAÑA 50x120	50	120	3	80	220
MENSULA DE VIENTO SIN PESTAÑA 50x140	50	140	4	80	170
MENSULA DE VIENTO SIN PESTAÑA 50x160	50	160	4	80	140
MENSULA DE VIENTO SIN PESTAÑA 50x180	50	180	4	80	120
MENSULA DE VIENTO SIN PESTAÑA 60x200	60	200	4	80	100



# FACHADA VENTILADA

norperfil

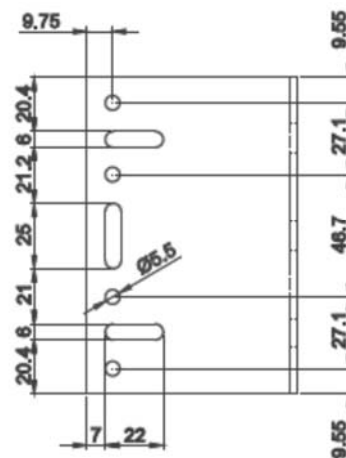
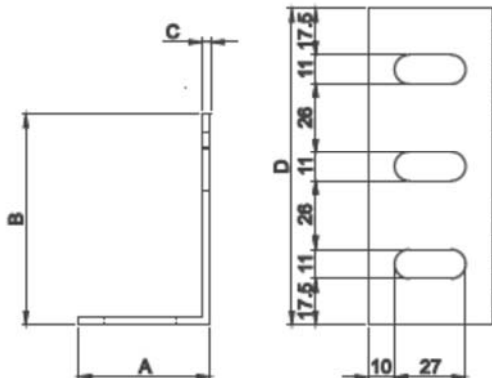

## Mensula de viento

DESCRIPCION	A	B	C	D	UNID/caja
MENSULA DE VIENTO SIN PESTAÑA 40x40	40	40	3	120	300
MENSULA DE VIENTO SIN PESTAÑA 40x60	40	60	3	120	230
MENSULA DE VIENTO SIN PESTAÑA 50x80	50	80	3	120	170
MENSULA DE VIENTO SIN PESTAÑA 50x100	50	100	3	120	150
MENSULA DE VIENTO SIN PESTAÑA 50x120	50	120	3	120	120
MENSULA DE VIENTO SIN PESTAÑA 50x140	50	140	4	120	90
MENSULA DE VIENTO SIN PESTAÑA 50x160	50	160	4	120	80
MENSULA DE VIENTO SIN PESTAÑA 50x180	50	180	4	120	70
MENSULA DE VIENTO SIN PESTAÑA 60x200	60	200	4	120	60

# FACHADA VENTILADA

norperfil

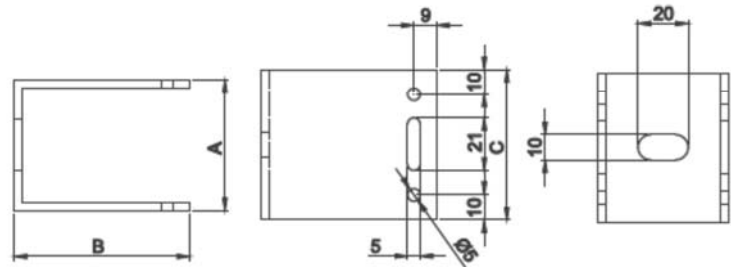

## Anclaje

DESCRIPCION	A	B	C	UNID/caja
ANCLAJE U 52x50	52	50	60	100
ANCLAJE U 52x70	52	70	60	100
ANCLAJE U 52x90	52	90	60	100
ANCLAJE U 52x110	52	110	60	100
ANCLAJE U 52x130	52	130	60	100

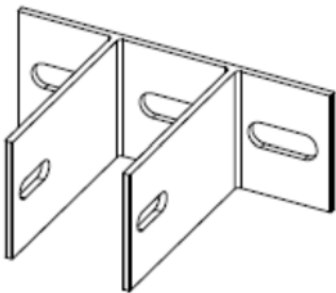

Anclaje doble T 59mm

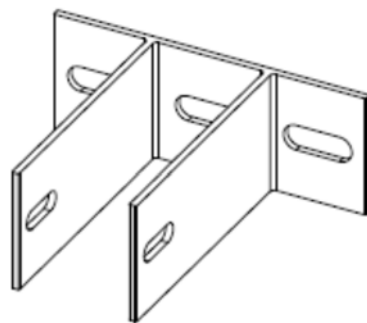

Anclaje doble T 74mm

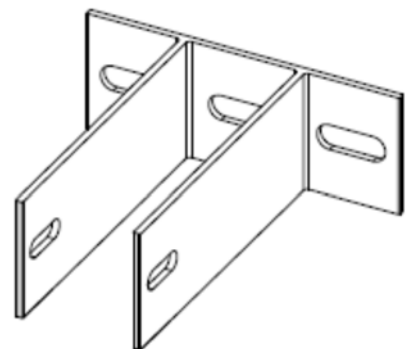

Anclaje doble T 89mm

# FACHADA VENTILADA

norperfil

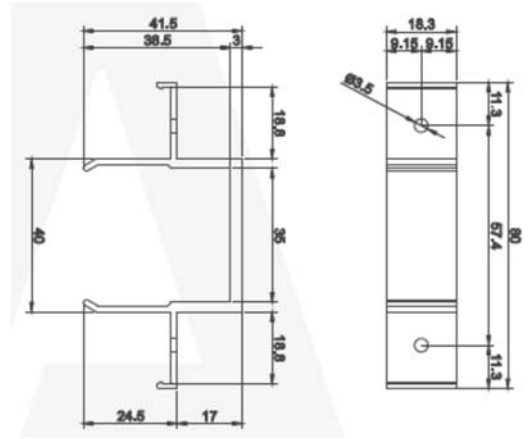
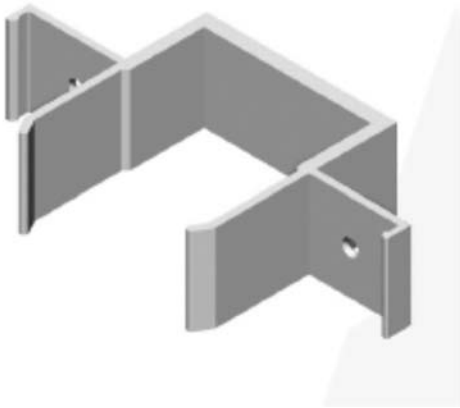

## Cuelgue Exterior

Esquema Montaje Anclaje+Omega+cuelgue c/junta

Cuelgue c/junta

