

MARCOS- HOJAS

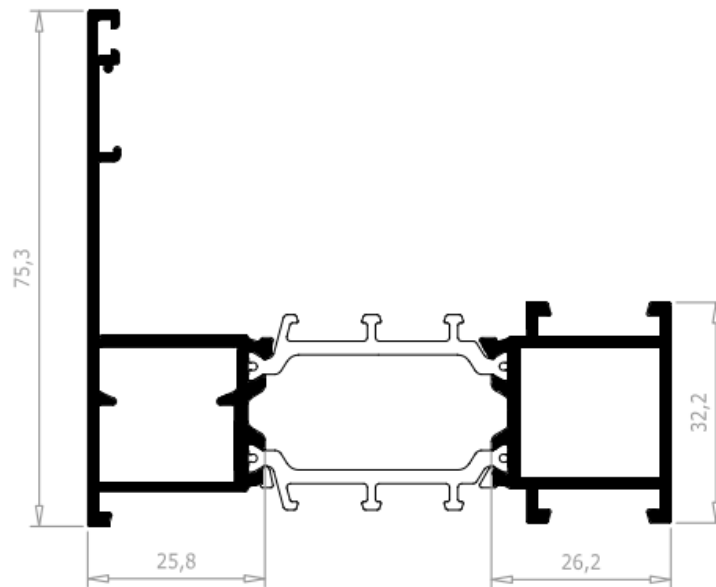

RT85105 MARCO DE VENTANA

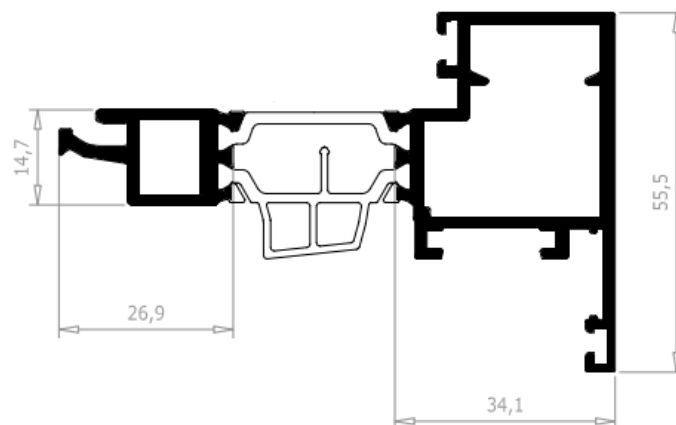

RT85112 HOJA VENTANA 27 mm

**HOJA OCULTA HO85 RPT**

norperfil

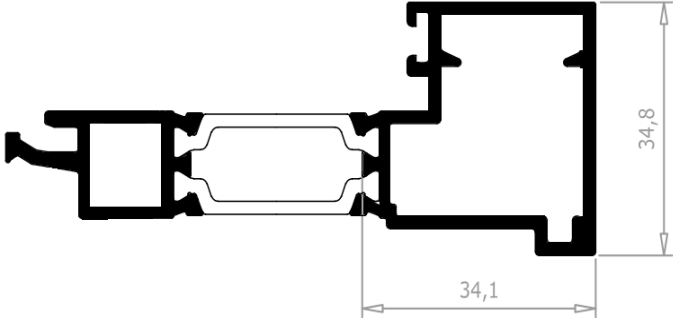

**RT85113 HOJA INVERSORA DE 27 mm**

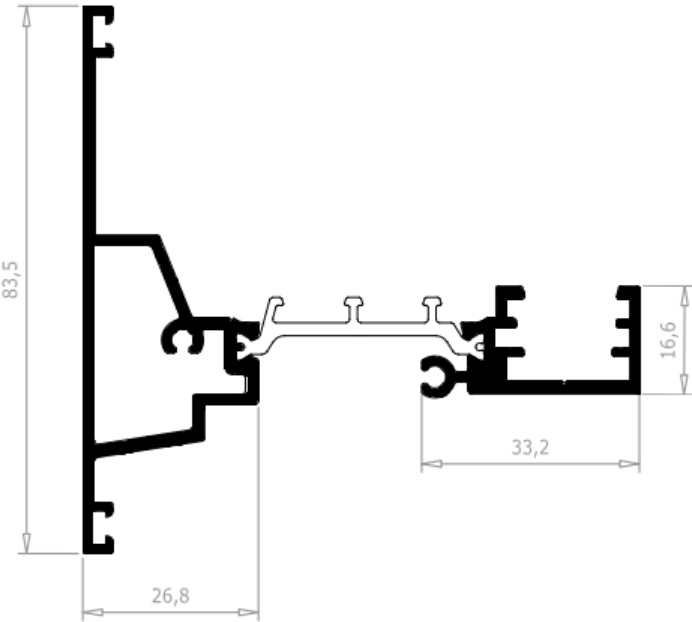

**RT85130 INVERSOR**

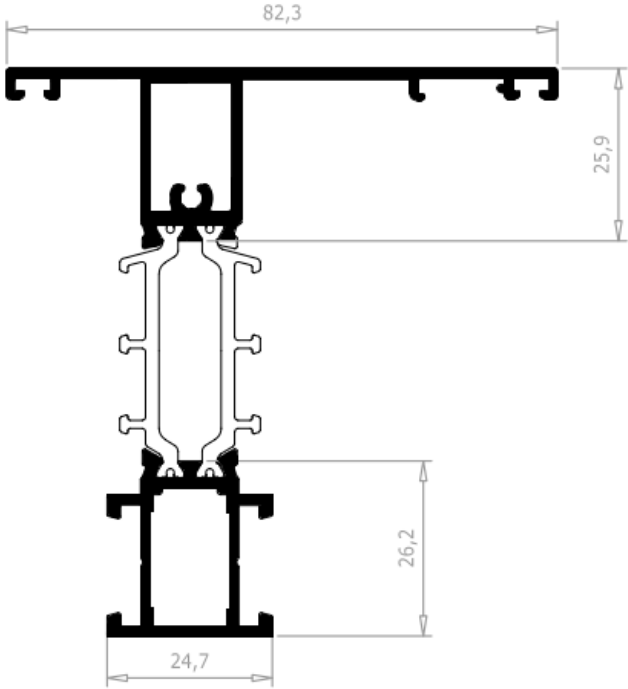

**RT85120** TRAVESAÑO ASIMETRICO

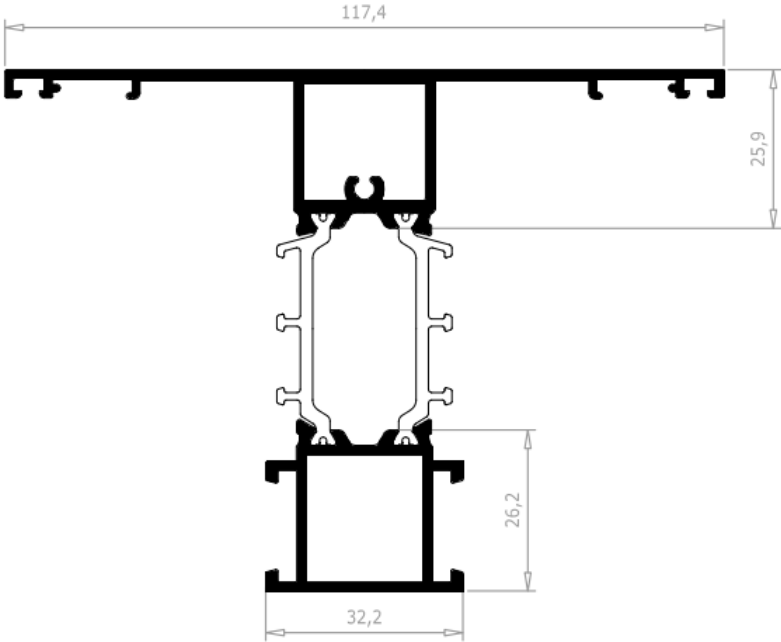

**RT85121** TRAVESAÑO DOBLE 117,4 mm

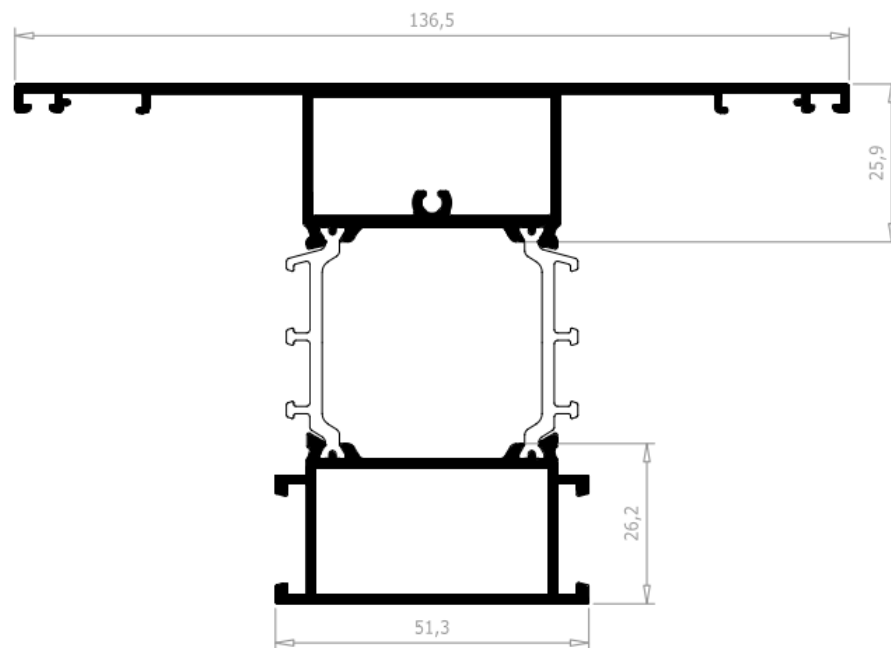

**RTxxxx** TRAVESAÑO DOBLE DE 136,5 mm

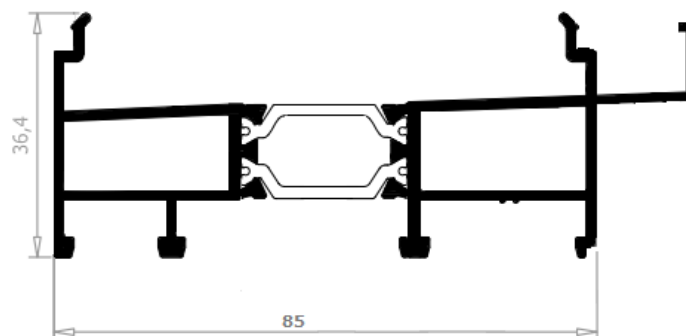

**RT85151** CONDENSACION

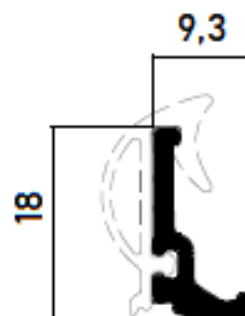
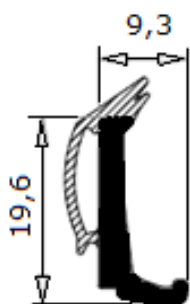

**78098** JUNQUILLO HOJA OCULTA (pvc)

**78078** JUNQUILLO HOJA OCULTA ALUM.

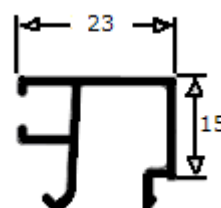
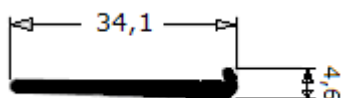

**78099** CALZO DE VIDRIO

**78090** JUNQUILLO RECTO DE 23 mm

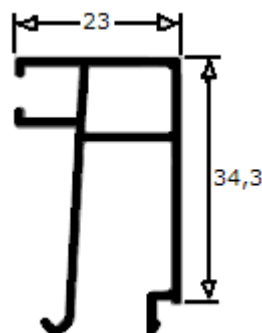
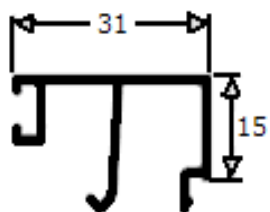

**78091** JUNQUILLO RECTO DE 31 mm

**78095** JUNQUILLO RECTO ALTO 23 mm

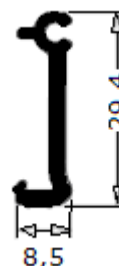
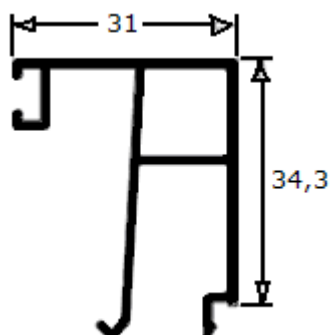

**78096** JUNQUILLO RECTO ALTO 31 mm

**78097** TOPE DE TRAVESAÑO

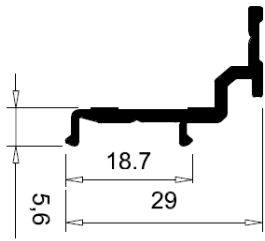

**78969**

CLIP TAPAJUNTAS

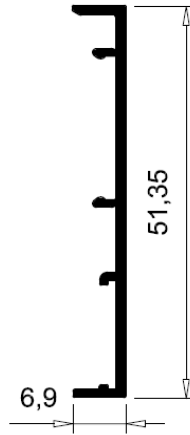

**78961**

JAMBA RECTA DE 50 mm

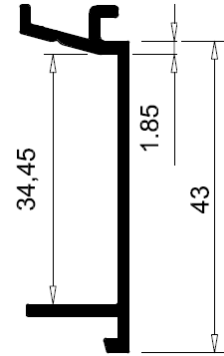















**78975**

TAPA GUIA PERSIANA

## Relación de accesorios

### ESCUADRAS Y TACOS

	Referencia: 0423 Descripción: Escuadra inyección Cx20x11x10 Fabricante/Proveedor: SAE		Referencia: 0453 Descripción: Escuadra inyección Cx28x21x10 Fabricante/Proveedor: SAE		Referencia: 4175DX Descripción: Escuadra inyección Cx20x20x10 Fabricante/Proveedor: SAE
	Referencia: A7101 Descripción: Escuadra inyección Cx9x11x5 Fabricante/Proveedor: SAE		Referencia: 4710B-1Alu Descripción: Escuadra alineamiento Fabricante/Proveedor: SAE		Referencia: 0706 Descripción: Escuadra alineamiento Inox Fabricante/Proveedor: BIPLAXT
	Referencia: 2023 Descripción: Escuadra alineamiento 5x58 Fabricante/Proveedor: SAE		Referencia: 2013 Descripción: Escuadra alineamiento 2x13 Fabricante/Proveedor: SAE		Referencia: 12-2010C Descripción: Escuadra regulable 20x10 Fabricante/Proveedor: SAE
	Referencia: 12-910C Descripción: Escuadra regulable 9x10 Fabricante/Proveedor: SAE		Referencia: 17-1714C Descripción: Escuadra bloqueo Fabricante/Proveedor: ANUDAL		Referencia: 17-1911C Descripción: Escuadra bloqueo Fabricante/Proveedor: ANUDAL
	Referencia: U00-1918 Descripción: Taco unión travesaño Fabricante/Proveedor: ANUDAL		Referencia: 0092/400 Descripción: Espina con mango 3x9,5 mm. Fabricante/Proveedor: SAE		

### JUNTAS

	Referencia: DU1350 Descripción: Junta acristalamiento exterior 3 mm. Fabricante/Proveedor: SAE		Referencia: 30072029 Descripción: Junta acristalamiento exterior HD Fabricante/Proveedor: SAE		Referencia: P-1150 Descripción: Junta acristalamiento interior 2 mm. Fabricante/Proveedor: SAE
	Referencia: P-2423 Descripción: Junta acristalamiento interior 3-4 mm. Fabricante/Proveedor: SAE		Referencia: P-1987 Descripción: Junta acristalamiento interior 4-5 mm. Fabricante/Proveedor: SAE		Referencia: P-805 Descripción: Junta acristalamiento interior 5-6 mm. Fabricante/Proveedor: SAE
	Referencia: P-1849 Descripción: Junta acristalamiento interior 6-8 mm. Fabricante/Proveedor:		Referencia: P-2424 Descripción: Junta acristalamiento interior 9-10 mm. Fabricante/Proveedor:		Referencia: CS3105 Descripción: Junta batiente hoja Fabricante/Proveedor:

## Relación de accesorios

	Referencia: DU0239
	Descripción: Junta central
	Fabricante/Proveedor: SAE

### AISLANTES

	Referencia: 40007020
	Descripción: Espuma autoadhesiva 20x30 mm

	Referencia: 40003020
	Descripción: Espuma autoadhesiva 30x5 mm

	Referencia: 40008026
	Descripción: Espuma termoaislante 29x10 mm

	Referencia: 40011026
	Descripción: Espuma termoaislante 34x17 mm

	Referencia: 40009026
	Descripción: Espuma termoaislante 12x9 mm

### OTROS

	Referencia: 28016
	Descripción: Juego de tapas inversoras CE
	Fabricante/Proveedor: SAE

	Referencia: 98005021
	Descripción: Juego de fresas retestado travesaño
	Fabricante/Proveedor: ALPEMETAL

	Referencia: 1741
	Descripción: Ruleta auxiliar para junta central
	Fabricante/Proveedor: SAE

### UTILLAJES

	Referencia: 99007021
	Descripción: Troquel mecanizado
	Fabricante/Proveedor: ALPEMETAL

	Referencia: P17/17 // P170/17
	Descripción: Punzonadora para 17-1714C y 17-1911C
	Fabricante/Proveedor: ANUDAL



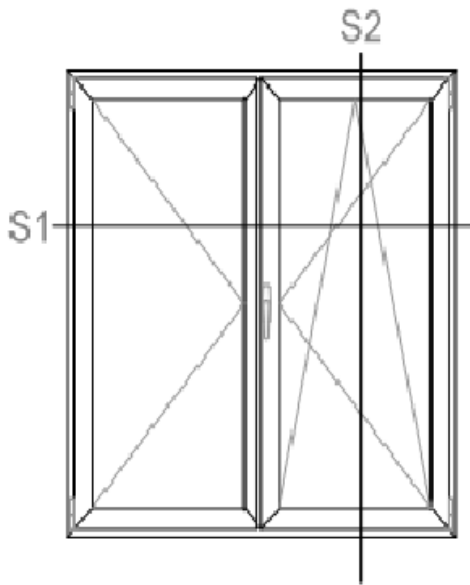

Sección 2

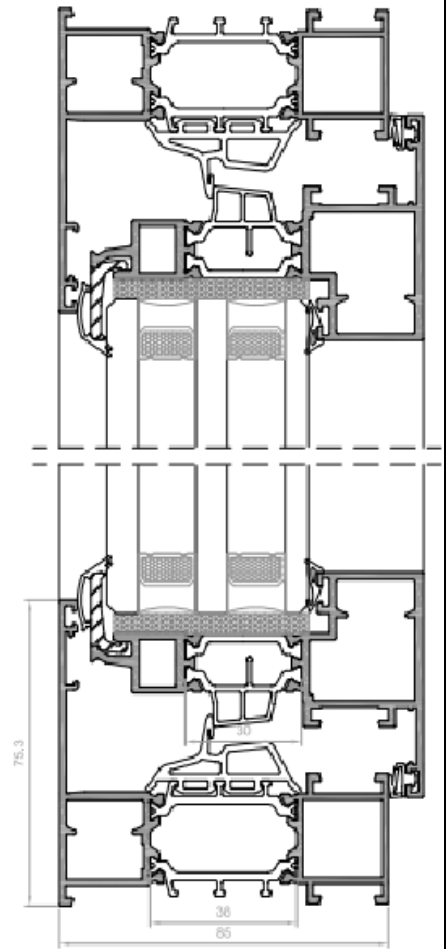

Sección 1

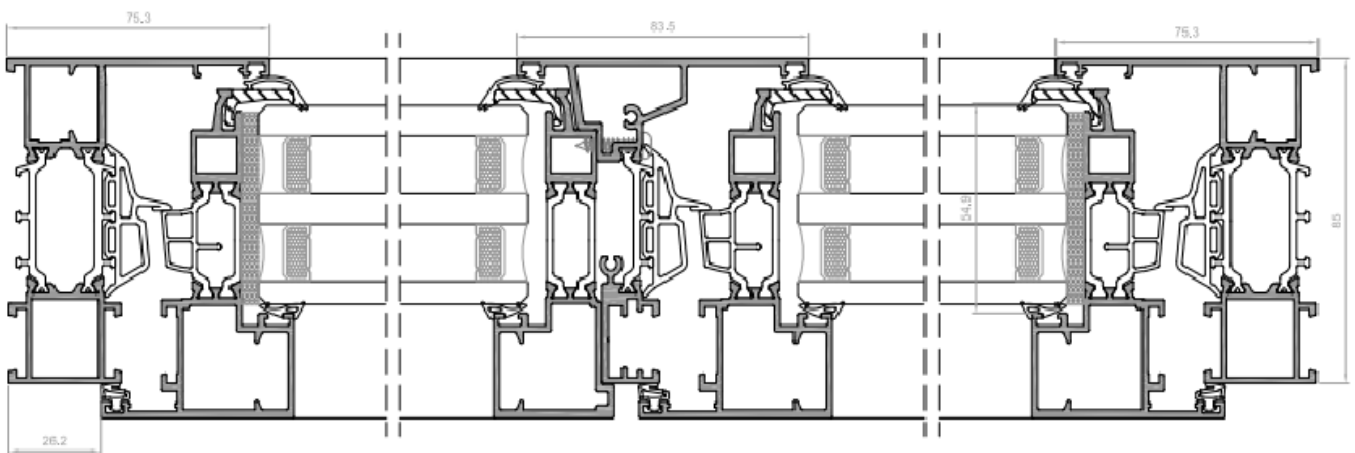

### Sección 4

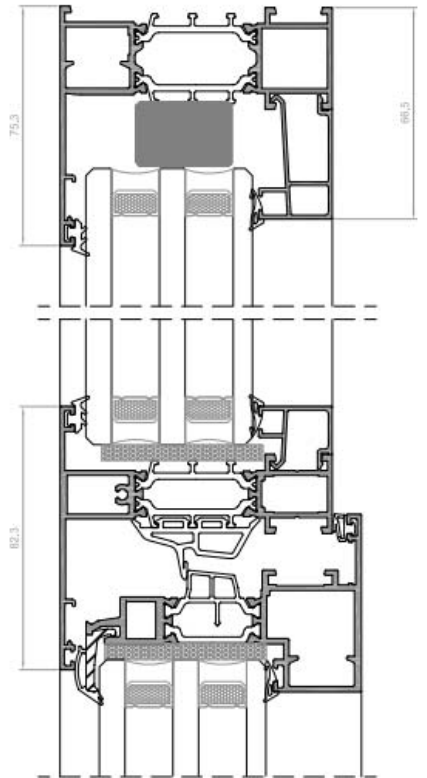
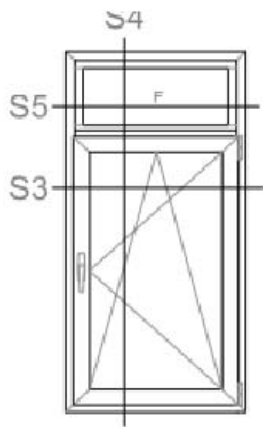

### Sección 3

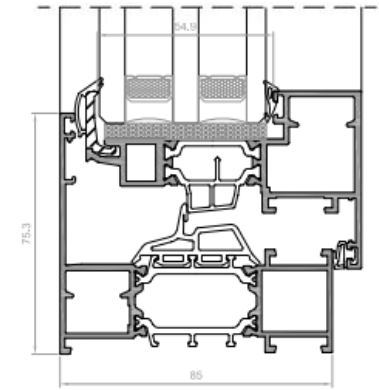
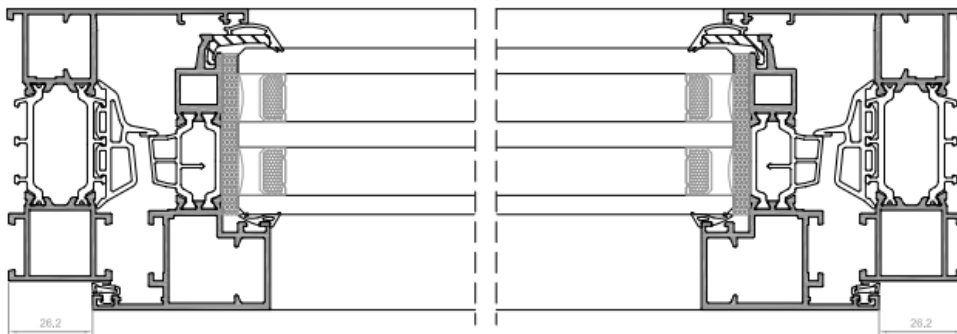

### Sección 5

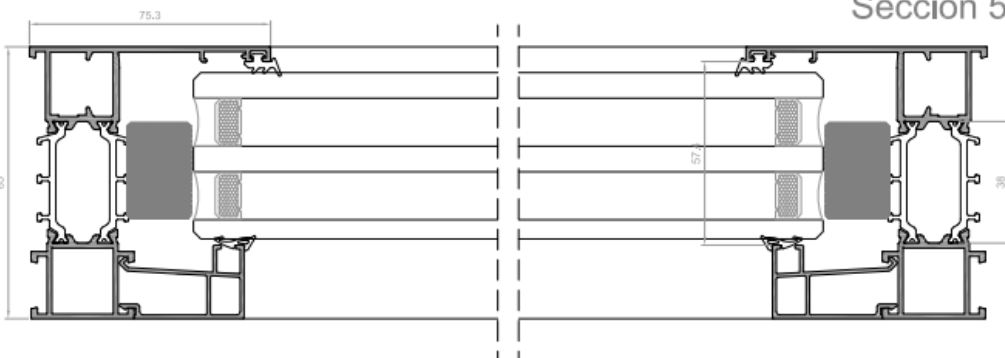

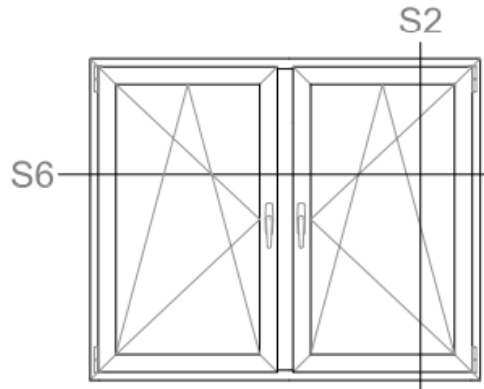

Sección 6

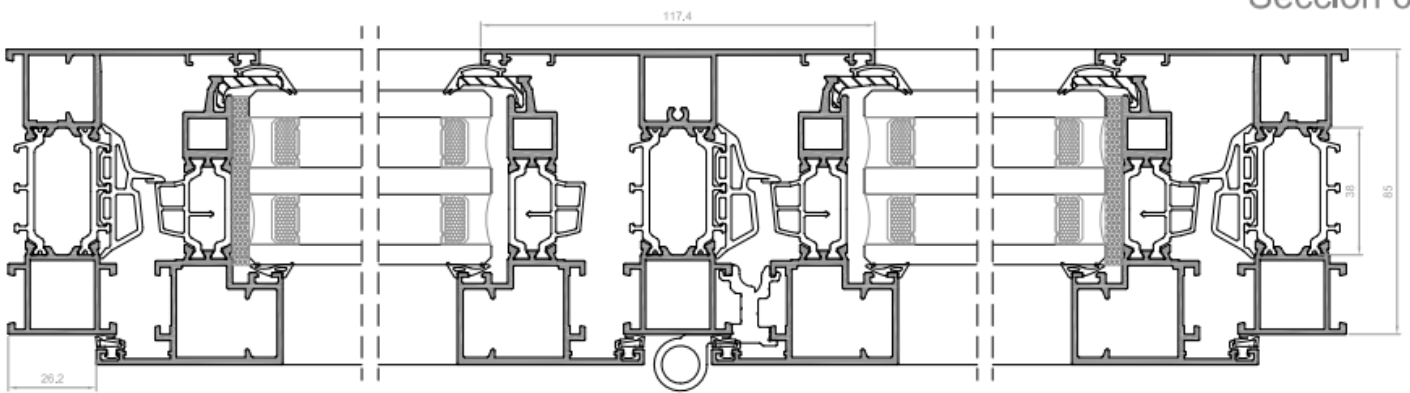

Sección 6 (variante)

